

ZAMPERLA INC.  
49 Fanny Road  
Parsippany, New Jersey 07054-0598  
USA  
Phone: 973 334 8133 Fax: 973 334 6880

Bulletin No: 99 RS1
Release Date: 4/1/99
Effective Date: 4/1/99
Supersedes:
Completion Date: As soon as possible
Page: 1 of 4

## SERVICE BULLETIN

Ride Manufacturer: Zamperla Inc.	Affected Production Dates:
Ride Name: Rotoshake	Affected Serial Nos.: RS42F153US95
Model Number: Rotoshake	

**Abstract Of Issue:**

Cracks have been found in the welds located at the connection of the fork arms to the central main arm.  
See areas indicated on the accompanying diagram.

**Reason For Release:**

Same.

**Action To Be Taken:**

Magnetic particle testing by a certified NDT technician

**Detail Of Issue:**

If cracks have been detected in the above mentioned welds and confirmed, please contact Zamperla Inc. for  
Notification of repair procedure.

**Future Action To Be Taken:**

Magnetic particle testing by a certified NDT technician annually.

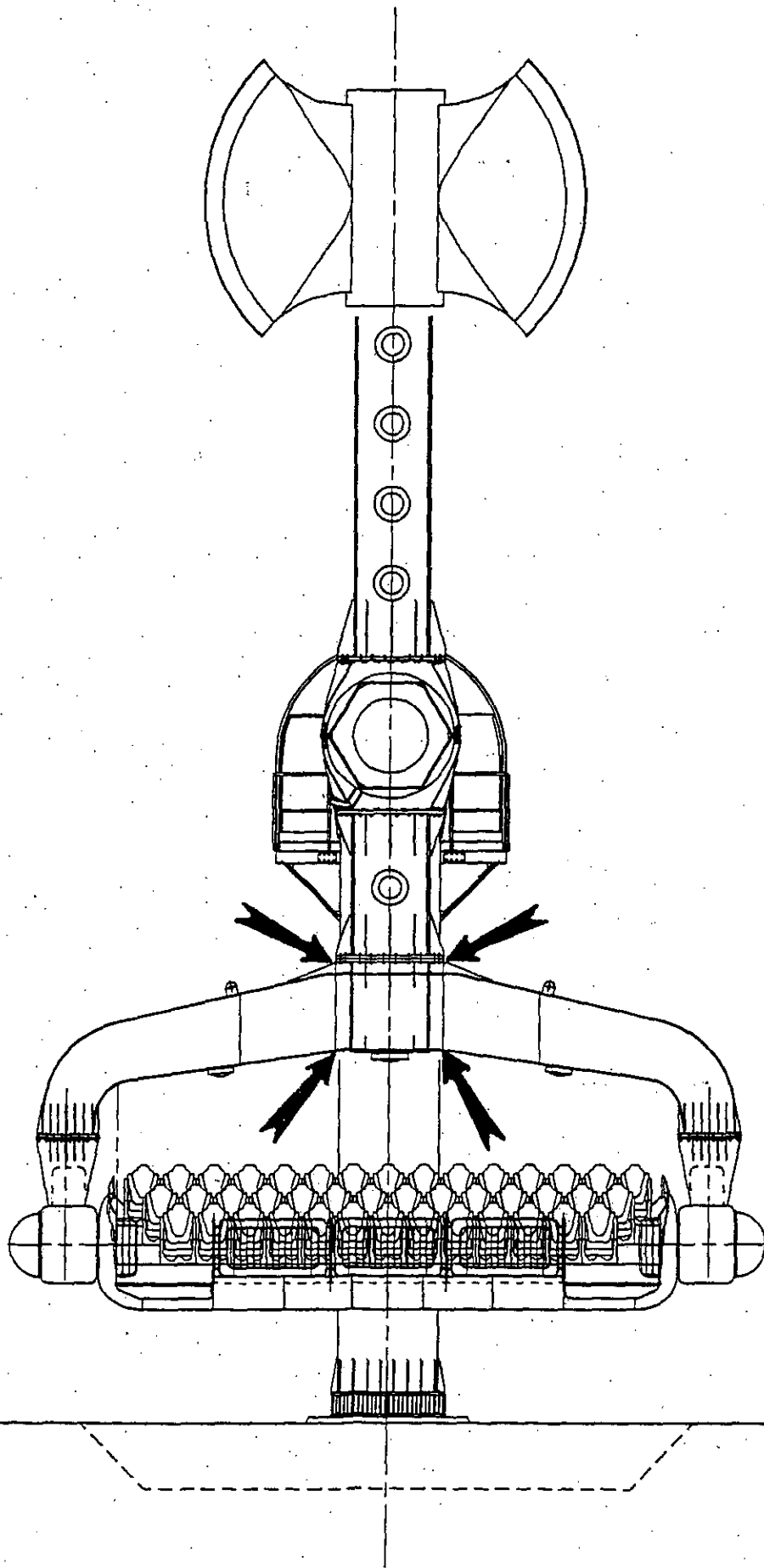

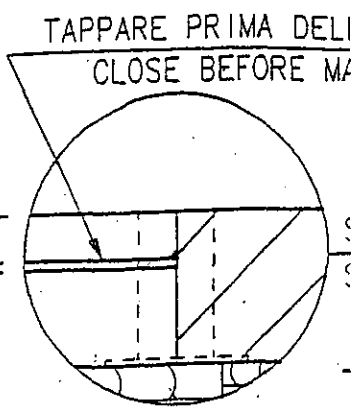
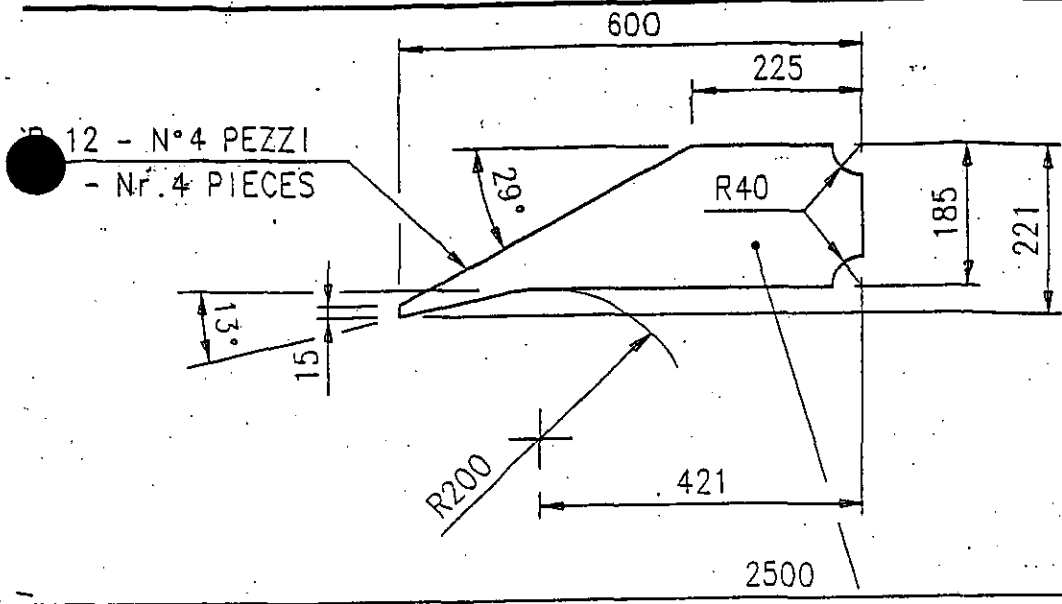

CONTROLLO ULT  
 ULTRASON

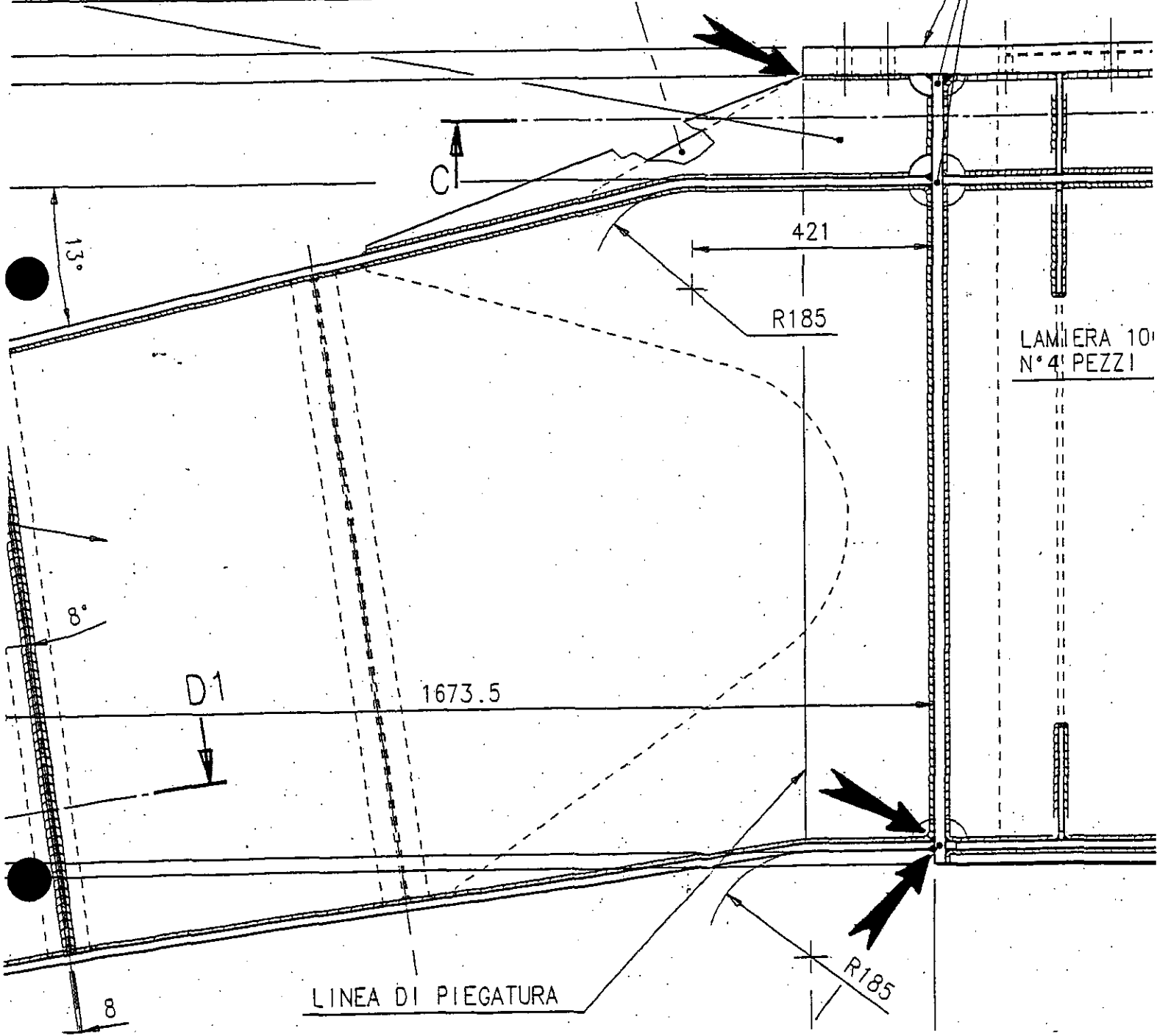

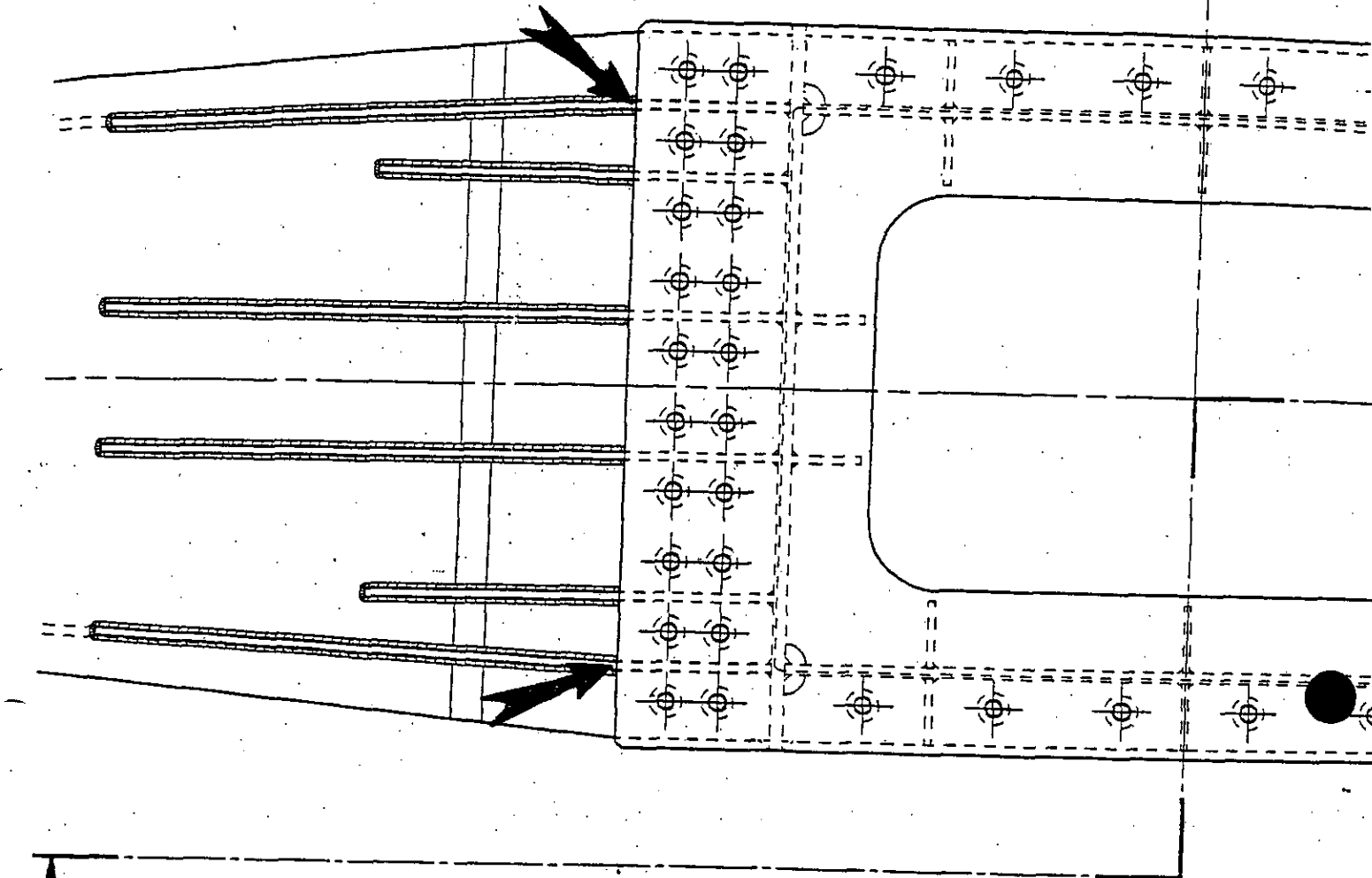

A

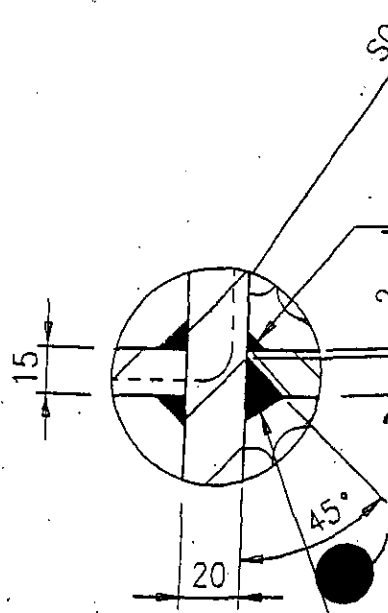
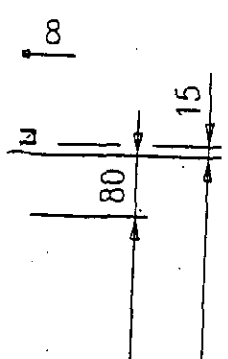

CONTROLLO MT89005 REV.A 100%  
 MAGNETIC PARTICLE TEST MT89005 REV.A 100%